

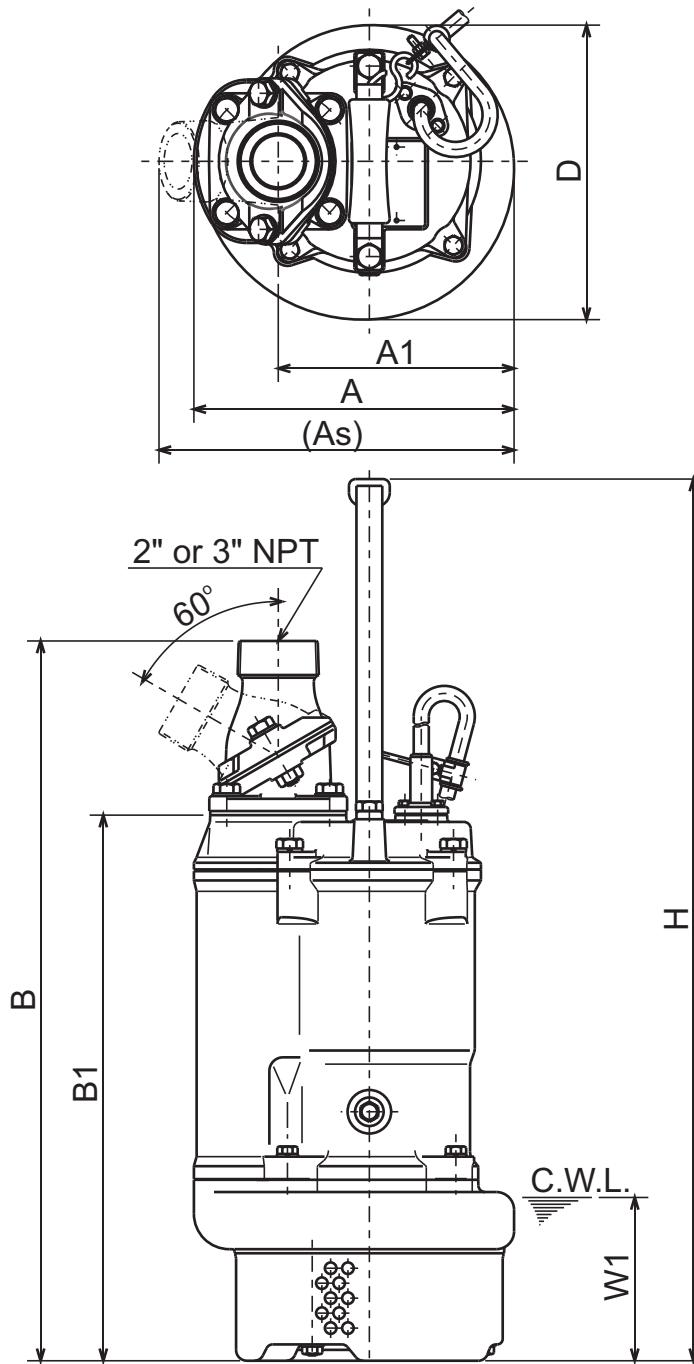

**KTZ - SERIES
DEWATERING PUMPS**

DIMENSIONS

**KTZ21.5-61
KTZ31.5-61**



C.W.L. : Continuous running Water Level

DIMENSIONS:USCS (Inch)

Model	HP	NOM. SIZE	Pump & Motor							C.W.L.		Wt. (lbs.)
			A	As	A1	B	B1	D	H	W1		
KTZ21.5-61	2	2"	9 1/4	10 1/4	6 13/16	20 13/16	15 13/16	8 1/2	25 1/2	4 3/4	77	
KTZ31.5-61	2	3"	9 1/4	10 9/16	6 13/16	20 13/16	15 13/16	8 1/2	25 1/2	4 3/4	75	

DIMENSIONS:METRIC (mm)

Model	kW	NOM. SIZE	Pump & Motor							C.W.L.		Wt. (kg)
			A	As	A1	B	B1	D	H	W1		
KTZ21.5-61	1.5	50	235	261	173	529	401	216	648	120	35	
KTZ31.5-61	1.5	80	235	268	173	529	401	216	648	120	34	